

EIO INTRINSICALLY SAFE FULLY PORTED VALVES



EIO - □ □ - 15.5 - □

Standard Mount



Manifold Mount



EIO - □ □ - 15.5 - □ C

Standard Mount



Manifold Mount



Type: 2-Way or 3-Way Poppet, Fully Ported

Medium: Air (40 micron filtration)

Temperature Range: 30° - 180°F

Input Pressure: 28 Hg. Vac to 105 psig; 0-7 bar
 28 Hg. Vac to 50 psig (L); 0-3.5 bar
 28 Hg. Vac to 25 psig (H); 0-1.8 bar

Air Flow: 0.6 scfm @ 100 psig; 15 l/min @ 7 bar
 0.5 scfm @ 50 psig (L); 15 l/min @ 3.5 bar
 0.45 scfm @ 25 psig (H); 14 l/min @ 1.8 bar

Voltages: 15.5 VDC

Power Consumption: 0.67 watt at rated voltage

Response: 5 - 10 milliseconds @ 100 psig

Ports: Inlet - #10-32 (M5), Outlet - #10-32 (M5) - on std.

Metric: Add -M5 to Part Number

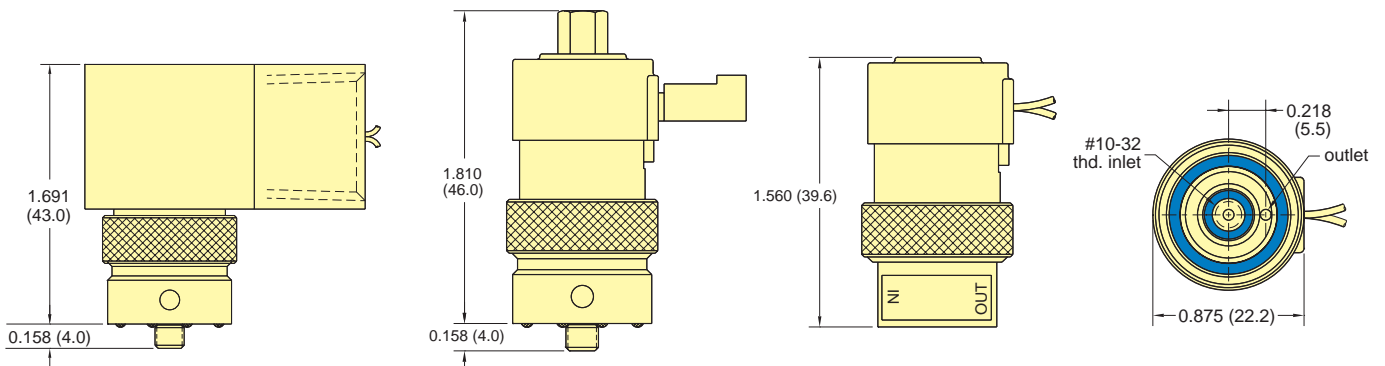

For Cable and Connectors, see Page 187.